

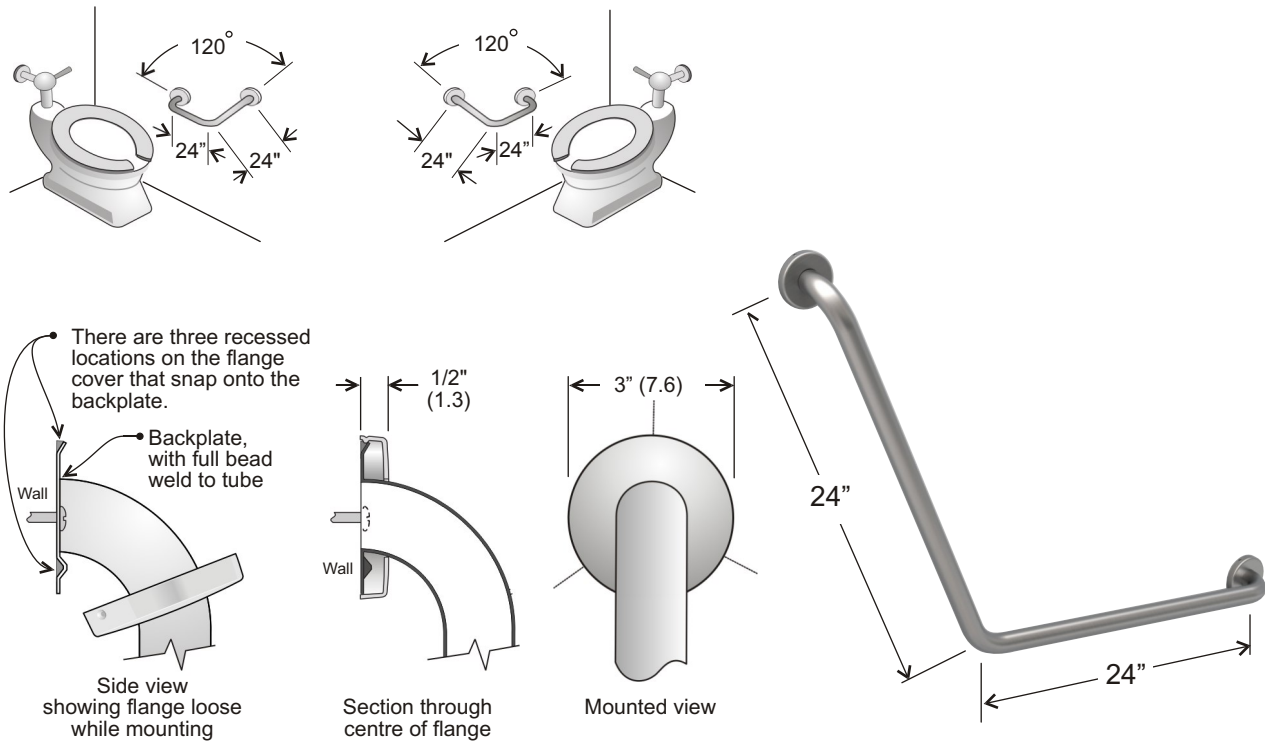

Hygienic Solutions at Work

Ready to Ship Stock Series Grab Bars, Stainless Steel

Code 1002NP 24x24": 1-1/2" dia. Stainless steel, peened finish



Concealed mounting screws, using snap flange, on "SP & NP" codes

Specifications:

The Frost NP series stock grab bars are of an all stainless steel construction. The brushed and peened finish make this an attractive, cost effective product to specify for any installation. Stamped flange is 12 gauge stainless steel with a full 360 degree bead weld to the 18 gauge stainless steel tubing. Features concealed mounting detailing as shown in the illustration above.

Barrier Free Access:

The Frost NP grab bar series comply with handicap codes requiring 1-1/2" bar diameter and wall clearance of 1-1/2". Barrier free access specifications may vary depending on jurisdiction.

Safety Warning: All grab bars must be installed by qualified trades persons. Installers must consult and comply with local building codes. Mounting hardware and other systems to be determined by contractor and installer pending specific structure, design, and conditions. All installations must be fully inspected and approved by property owners and maintenance personnel prior to product being put into use. Failure to comply to proper installation procedure will void warranty and may result in malfunctioning or injury.