



# ICON™



## Toilet Paper Dispensers

Engineered to provide you confidence, designed to elevate your space.





ICON COLLECTION

# Toilet Paper Dispensers







Elevate your space with the latest advancement in reliable dispensing. Thoughtfully engineered with an eye on aesthetics and sustainability, the Kimberly-Clark Professional™ ICON™ standard roll toilet paper dispenser refines every interaction of the dispensing experience from servicer to end-user.

Available in two flexible size offerings, horizontal and vertical.









## DISPENSER PRODUCT CODES

### HORIZONTAL MOUNT



-  Black Mosaic (58722)
-  Ebony Woodgrain (58732)
-  Silver Mosaic (53698)
-  Cherry Blossom (58742)
-  White Mosaic (58712)
-  Warm Marble (58752)

### VERTICAL MOUNT

-  Black Mosaic (58721)
-  Ebony Woodgrain (58751)
-  Silver Mosaic (53696)
-  Cherry Blossom (58731)
-  White Mosaic (58711)
-  Warm Marble (58741)



## PRODUCT FEATURES

-  Sleek and stylish yet suited for high-traffic restrooms with variable toilet paper roll options
-  Simplified installation process with custom engineered mounting brackets, a built-in level and clip-on mounting
-  Engineered with increased accessibility for a smooth, controlled opening experience that makes refilling a snap

ICON™ | Kimberly-Clark  
PROFESSIONAL

It's time to add style to hygiene.









ICON™ COLLECTION

# Toilet Paper

To learn more about bundles, please contact your Kimberly-Clark Professional Sales Representative or visit [www.KCProfessional.com](http://www.KCProfessional.com)



- ✓ ECOLOGO® Certified for reduced environmental impact
- ✓ FSC® Certified
- ✓ Meets EPA Guidelines, minimum post-consumer waste content: bathroom tissue 20%

STANDARD <span>✓✓✓</span>	PLUS <span>✓✓✓</span>	PREMIUM <span>✓✓✓</span>
 <p><b>Scott® Essential Coreless SRB Tissue</b> 04007</p> <p>1000 sts./roll</p> <p>✓✓✓</p>	 <p><b>Scott® Extra Soft Coreless SRB Tissue</b> 07001</p> <p>800 sts./roll</p> <p>✓✓</p>	 <p><b>Cottonelle® Paper Core High-Capacity SRB Tissue</b> 53862</p> <p>900 sts./roll</p> <p>✓✓</p>
	 <p><b>Scott® Pro Small Core SRB Tissue</b> 47305</p> <p>1100 sts./roll</p> <p>✓✓✓</p>	

# ICON™



## Dispenser collection

Engineered to provide you confidence, designed to elevate your space.

- ▶ Stylish faceplate options
- ▶ Cutting edge technology
- ▶ Designed with you in mind



## Reimagine the look and feel of your restroom.

### Kimberly-Clark Professional™ ICON™ Dispenser Collection

#### Automatic Roll Towel System

- Virtually noiseless—85% quieter than the leading competition<sup>1</sup>
- Proven 99.99% jam-free dispensing performance<sup>1</sup>
- Patented dual sensor technology
- Wall mount and stainless steel recessed options available

#### Coreless Standard Roll Bathroom Tissue System

- Engineered for less waste and fewer changeouts

#### Automatic Skin Care Dispenser

- Up to 60,000 hand washes per battery set
- Fast loading for easy servicing

## Kimberly-Clark Professional™ ICON™ Designer and Custom Faceplates

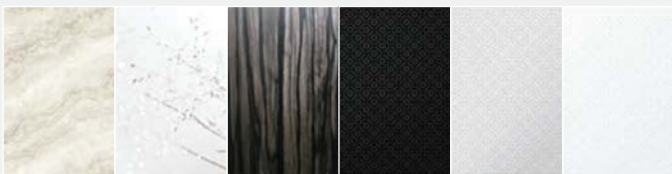

Available in six designer options.























For locations that demand intuitive design and clever engineering

ICON™



Recommended product solutions

<b>Kimberly-Clark Professional™</b> <b>ICON™ Dispenser Collection</b>	<b>Standard</b>	<b>Plus</b>			<b>Premium</b>	
 <p><b>Automatic Roll Towel Dispenser</b></p> <ul style="list-style-type: none"> <li>85% quieter than leading competition<sup>1</sup></li> <li>Over 150,000 dispenses on one set of batteries<sup>2</sup></li> <li>Practically stops jams before they happen with dual sensor technology</li> <li>Also available in customizable and stainless steel or custom faceplate options</li> </ul> <p>53691 / 53706</p>		<p>Scott® Pro Roll Towels</p>  <p>900' per roll</p> <p>43959</p>	<p>Scott® Pro Roll Towels</p>  <p>700' per roll</p> <p>53925</p>	<p>Scott® Pro High-Capacity Roll Towels</p>  <p>1,150' per roll</p> <p>25702</p>	<p>Kleenex® Roll Towels</p>  <p>700' per roll</p> <p>25637</p>	<p>Kleenex® 2-Ply Towels</p>  <p>500' per roll</p> <p>54471</p>
 <p><b>Coreless Standard Roll Bathroom Tissue Dispenser</b></p> <ul style="list-style-type: none"> <li>Sleek and stylish yet suited for high-traffic restrooms with variable toilet paper roll options</li> <li>Designed to get more out of your toilet paper supply to minimize waste with fewer changeouts</li> <li>Choose twin vertical or horizontal dispenser option</li> </ul> <p>53696 / 53698</p>	<p>Scott® Essential Coreless SRB Tissue</p>  <p>1,000 sts.</p> <p>04007</p>	<p>Scott® Extra Soft Coreless SRB Tissue</p>  <p>800 sts.</p> <p>07001</p>	<p>Scott® Pro Paper Core High-Capacity SRB Tissue</p>  <p>1,100 sts.</p> <p>47305</p>	<p>Cottonelle® Paper Core High-Capacity SRB Tissue</p>  <p>900 sts.</p> <p>53862</p>		
 <p><b>Automatic Skin Care Dispenser</b></p> <ul style="list-style-type: none"> <li>Fast loading for easy servicing with increased accessibility and a smooth, controlled opening experience</li> <li>Touchless operation helps reduce the risk of cross-contamination and the spread of germs</li> <li>Customizable</li> </ul> <p>54191</p>	<p>Scott® Green Certified Foam Skin Cleanser</p>  <p>91591</p>	<p>Scott® Foam Skin Cleanser with Moisturizers</p>  <p>91592</p>		<p>Kleenex® Botanics Luxury Foam Skin Cleanser</p>  <p>52788</p>		
	<p>Scott® Foam Hand Sanitizer<sup>3</sup></p>  <p>12979</p>	<p>Scott® Moisturizing Foam Hand Sanitizer</p>  <p>91590</p>		<p>Scott® Ultra Moisturizing Foam Hand Sanitizer</p>  <p>34643</p>		
 <p><b>Unmistakably Scott®, Confidently Cottonelle® and Delightfully Kleenex®</b></p> <p>Product features Elevated Scott® Design, Cottonelle® Design or Kleenex® Design visual paper enhancement</p>				<p><b>Complement with</b></p> <p>Kleenex® Facial Tissue</p>  <p>21400</p>		

To learn more, please contact your Kimberly-Clark Professional Sales Representative or visit [www.KCProfessional.com](http://www.KCProfessional.com). Contact Customer Service: 1-800-241-3146

©/™ Trademarks of Kimberly-Clark Worldwide, Inc. or its affiliates. Marques de commerce de Kimberly-Clark Worldwide, Inc. ou de ses sociétés affiliées. © KCWW. T1WF62 2/22



<sup>1</sup>Lifetime Warranty applies to proprietary dispensers while they are installed and the end-user account is exclusively using Kimberly-Clark Professional products for those dispensers. For more information, visit [www.KCProfessional.com/LifetimeWarranty](http://www.KCProfessional.com/LifetimeWarranty).

All dispensers listed, when installed properly, meet the ADA Standards for Accessible Design CFR Part 36, local rules may vary.

<sup>1</sup> Based on Kimberly-Clark Professional lab testing

<sup>2</sup> Based on an average of 30,000 dispenses per year using historical usage and foot traffic data

<sup>3</sup> Not formulated with alcohol

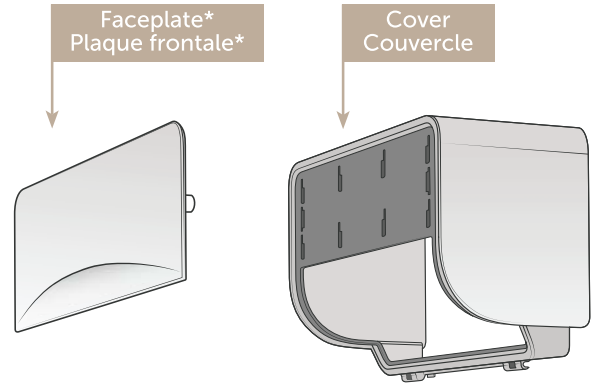

## Faceplate Replacement

## Remplacement de la plaque frontale

1. Remove the sliding door from the dispenser cover by sliding it to the center and pulling down on it shown here. Locate the sliding track feature under the faceplate that the top tab feature of the sliding door slides along. Release the tab feature on the door by pulling down on the sliding door, flexing it free from the track.

Retirer le panneau coulissant du couvercle du distributeur en l'amenant vers le centre et en l'abaissant tel qu'illustré ici. Repérer la glissière sous la plaque frontale sur laquelle coulisse la languette supérieure du panneau coulissant. Libérer la languette du panneau coulissant en tirant vers le bas pour le dégager de la glissière.

2. To unlock the dispenser, insert key into lock and rotate the key one quarter turn. Gently pull the cover forward.

Pour déverrouiller le distributeur, insérer la clé dans le verrou et faire tourner d'un quart de tour vers le mur. Tirer doucement le couvercle vers l'avant.

3. The key may be removed at this point. The cover will automatically open, do not force.

Retire la clé. Le couvercle s'ouvrira automatiquement, ne pas forcer.

4. If there are screws securing the faceplate to the dispenser cover, remove them and dispose of them properly.

S'il y a des vis maintenant la plaque frontale du couvercle du distributeur, enlevez-les et éliminez-les correctement.

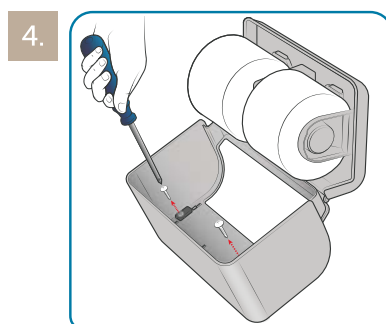
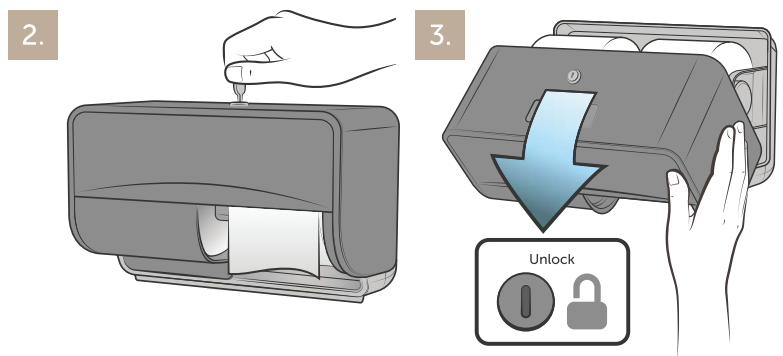
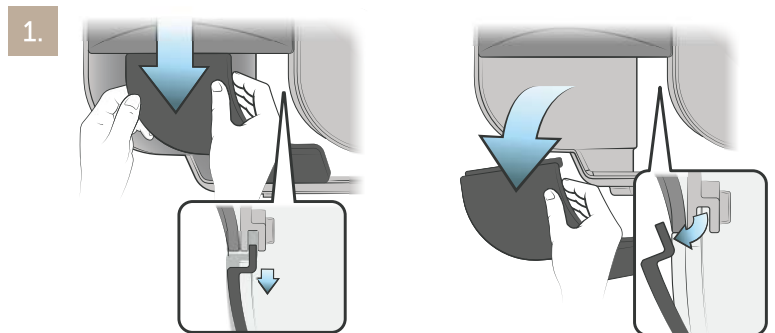

5. Locate the locking features on the faceplate on the inside cover. Release the faceplate by lifting on the release lever (red) and pushing up on the push tab (blue). Brace the underside of the faceplate. Brace the underside of the faceplate.

Repérer les points de verrouillage de la plaque frontale à l'intérieur du couvercle. Dégager la plaque frontale en soulevant le levier de dégagement (rouge) et en appuyant sur la languette poussoir (bleue). Prendre la plaque frontale par le dessous.

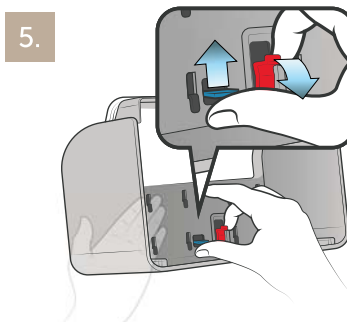

6. After the faceplate is released, remove it by taking it out from under the cover. Make sure to brace the underside of the faceplate so it doesn't fall to the floor once released.

Une fois la plaque frontale relâchée, retirez-la en la retirant depuis le dessous du couvercle. Veiller à maintenir le dessous de la plaque frontale pour qu'elle ne tombe pas par terre une fois dégagée.

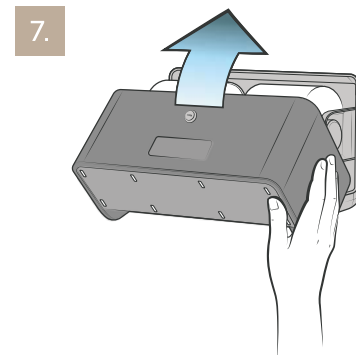
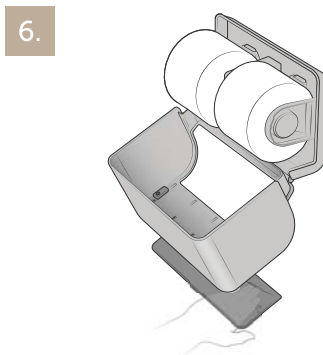

7. Close the cover completely and make sure it locks shut.

Rabattre totalement le couvercle et vérifier qu'il est bien verrouillé.

8. Align the locking features on the new faceplate (red) to the corresponding slots on the dispenser front face (blue). Push the new faceplate up against the dispenser and slide it up to slot it into the locking features.

Alignez les points de verrouillage sur la nouvelle plaque frontale (rouge) sur les encoches correspondantes de la face avant du distributeur (bleu). Appuyez la nouvelle plaque frontale contre le distributeur et faites-la glisser pour l'insérer dans les points de fixation.

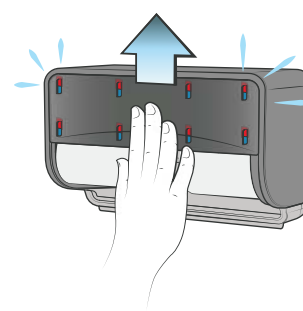
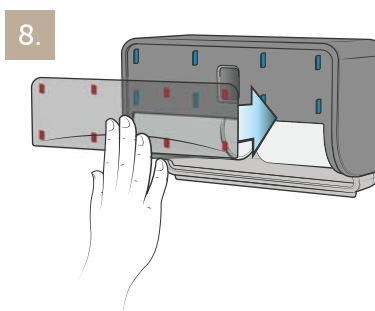

9. Replace the sliding door by inserting the bottom tab of the sliding door into the sliding track feature near the dispenser hinge. Once the bottom tab of the sliding door is inserted in the track, using both hands, flex the cover until the top tab feature of the sliding door fits underneath the sliding track feature under the faceplate.

Remettre en place le panneau coulissant en insérant la languette inférieure du panneau coulissant dans la glissière près de la charnière du distributeur. Une fois que la languette inférieure du panneau coulissant est insérée dans la glissière, à l'aide des deux mains, faire fléchir le couvercle jusqu'à ce que la languette supérieure du panneau coulissant s'insère dans la glissière sous la plaque frontale.

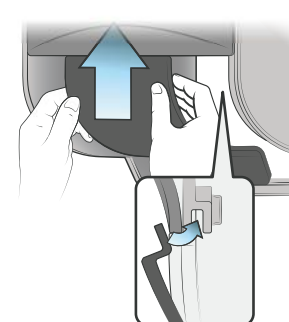
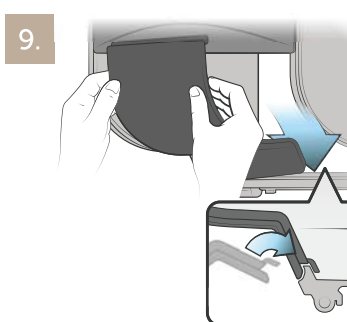

**\* For additional faceplates, contact your sales representative.**  
**\* Pour des plaques frontales supplémentaires, contactez votre représentant des ventes.**



## Legal/ Juridique

©/™ Trademarks of Kimberly-Clark Worldwide, Inc. or its affiliates. © KCWW  
 ©/™ Marques de commerce de Kimberly-Clark Worldwide, Inc. ou de ses filiales. © KCWW  
 Parts made in Mexico and China; Assembled in Mexico / Pièces fabriquées au Mexique et en Chine, et assemblées au Mexique / Partes hechas en México y China, armado en México / Teile hergestellt in Mexiko und China, montiert in Mexiko / Peças produzidas no México e na China, montagem no México / 部件在墨西哥和中国制造, 在墨西哥组装  
 Distributed in the U.S. by Kimberly-Clark Global Sales, LLC, Roswell, GA 30076-2199  
 Distributed in Canada by Kimberly-Clark Inc., Mississauga, Ontario L5B 3Y5  
 Kimberly-Clark Europe Limited, Walton Oaks, Dorking Road, Tadworth, Surrey, KT20 7NS, UK  
 www.kcprofessional.co.uk +44 (0)1737 736000

Kimberly-Clark B.V., Copernicuslaan 35, 6716 BM Ede, Netherlands  
 Distributed in Australia by Kimberly-Clark Australia Pty. Ltd, Level 4, 100 Arthur Street, North Sydney, NSW 2060  
 Tel: 1800 647 994 www.kcprofessional.com.au  
 Distributed in New Zealand by Kimberly-Clark New Zealand, Level 2, 123 Carlton Gore Road, Newmarket, Auckland 1023, New Zealand Tel: 0800 447 814 www.kcprofessional.co.nz  
 中国责任单位: 金佰利(中国)有限公司 上海市黄浦区淡水路299号12楼 200025 咨询电话: 400 6517 268  
 www.kcprofessional.com.cn  
 Distributed in Singapore by Kimberly-Clark Singapore Pte. Ltd, 81 Tuas South Avenue 8, Singapore 637558.  
 Tel: 1 800 562 5275 www.kcprofessional.com.sg